

P PRIMO

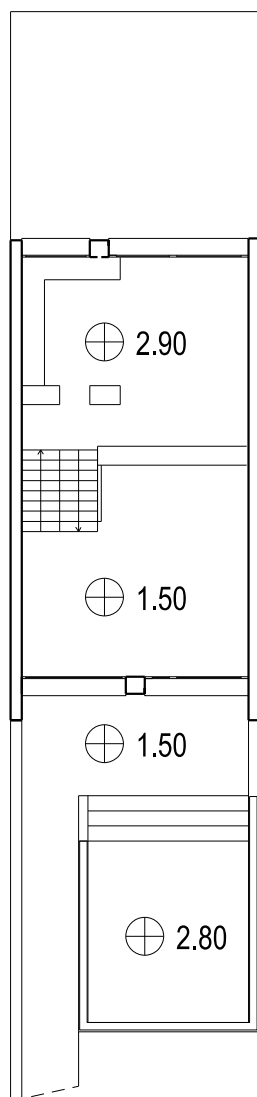

P RIALZATO

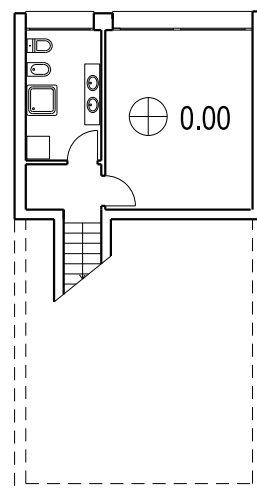

P SEMINTERRATO

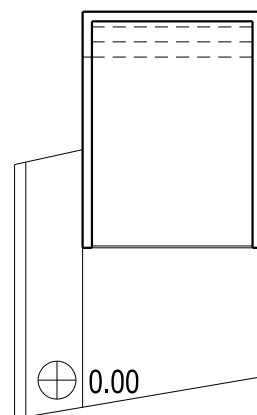

TIPOLOGIA S
SU MQ 160

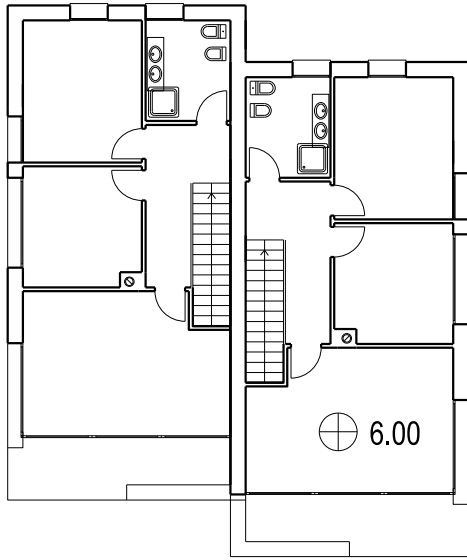

P PRIMO

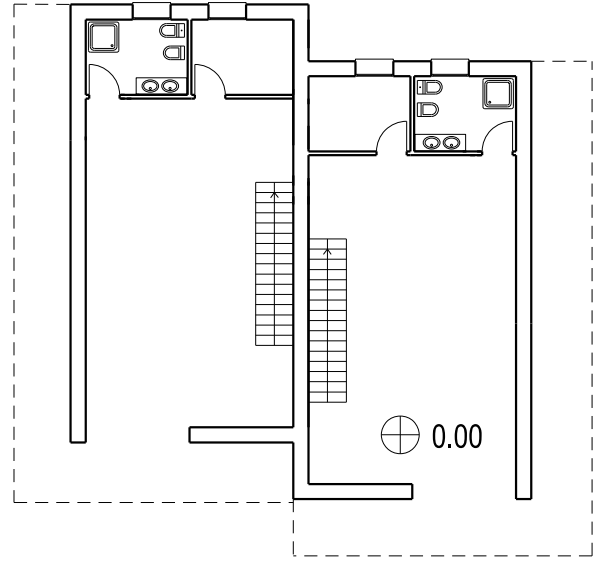

P SEMINTERRATO

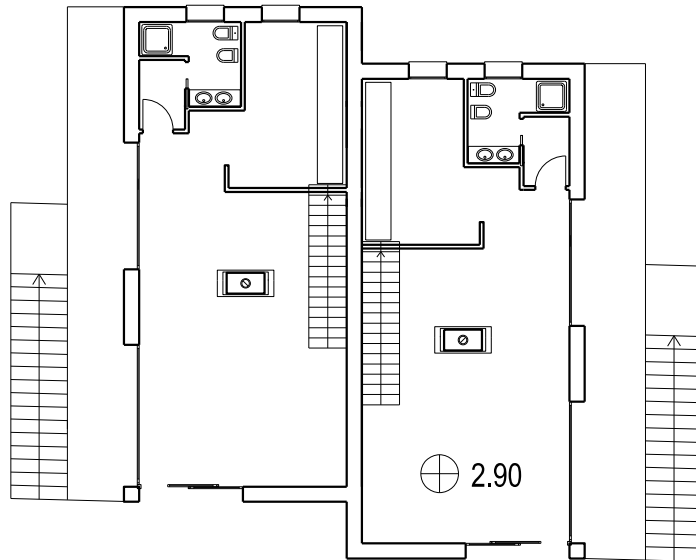

TIPOLOGIA C2
SU MQ 302

P RIALZATO

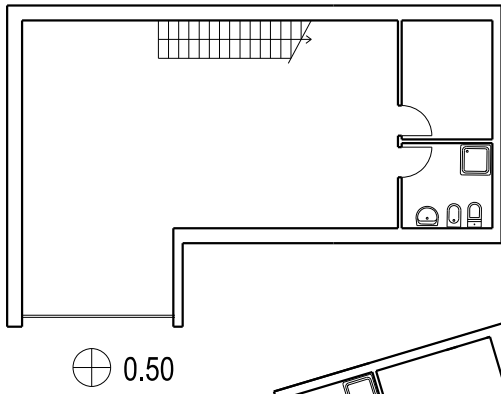

P SEMINTERRATO

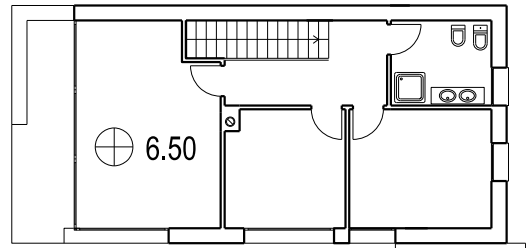

P PRIMO

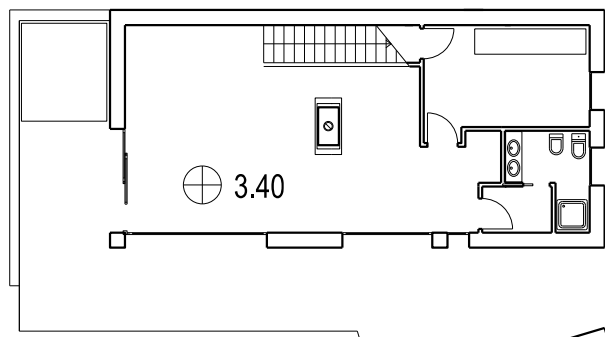
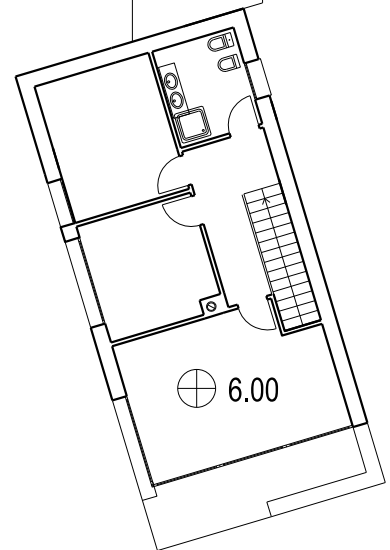
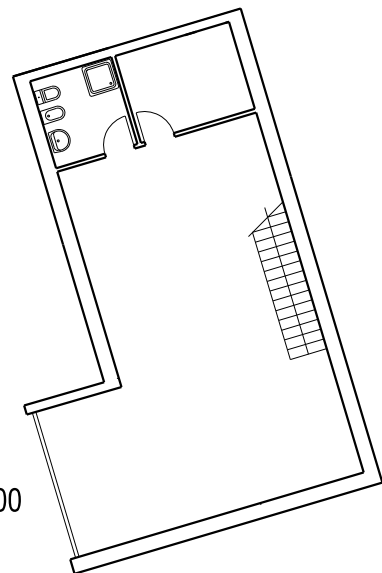

P RIALZATO

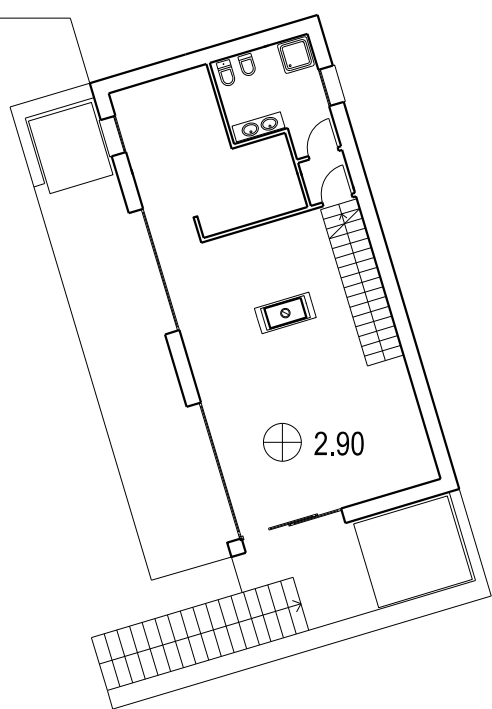

TIPOLOGIA C1 SU MQ 309

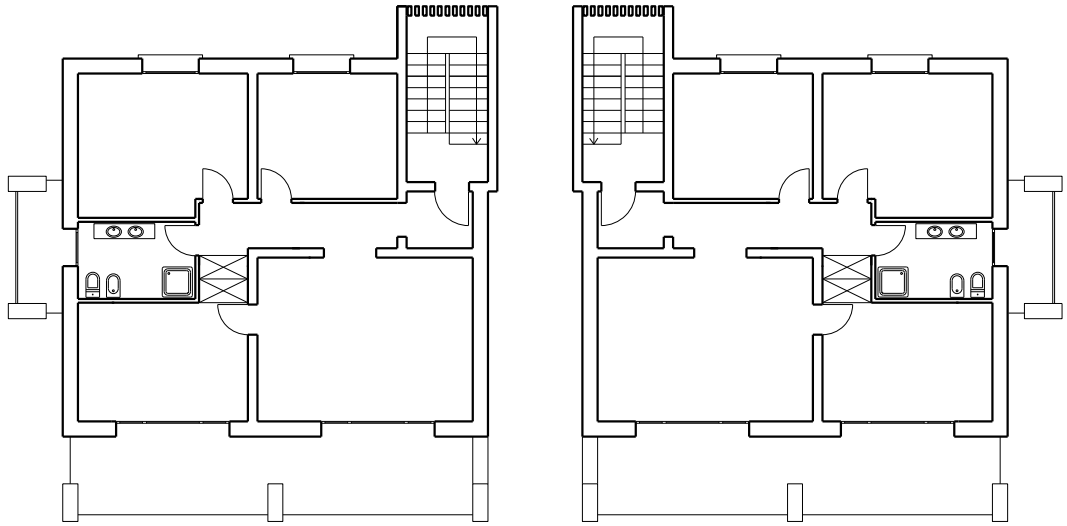

P PRIMO

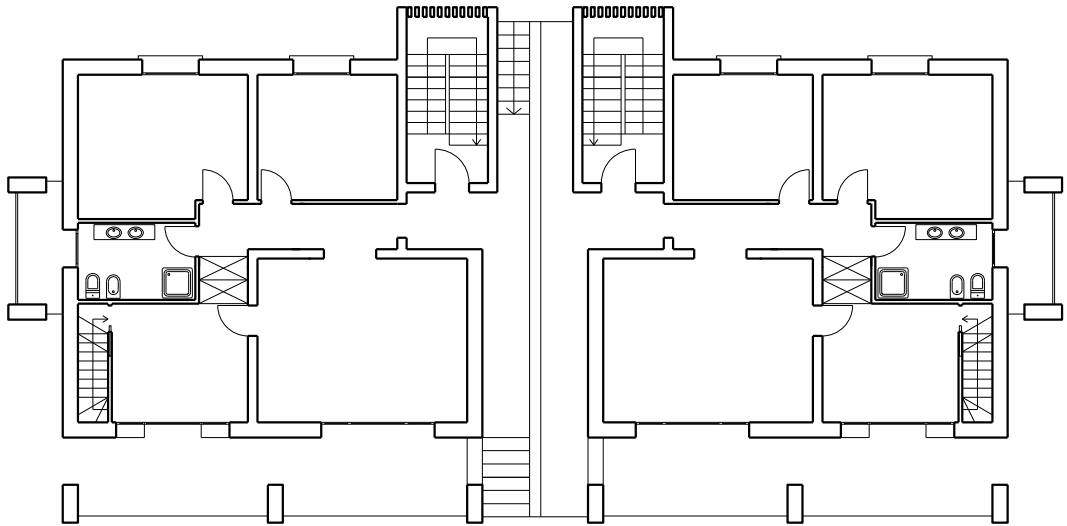

P RIALZATO

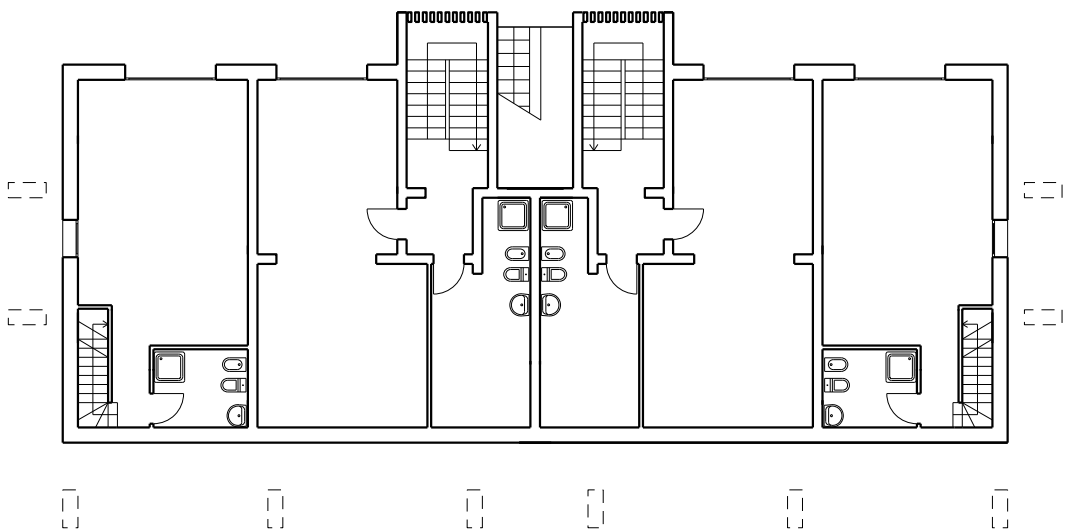

P SEMINTERRATO

TIPOLOGIA B1
SU MQ 460

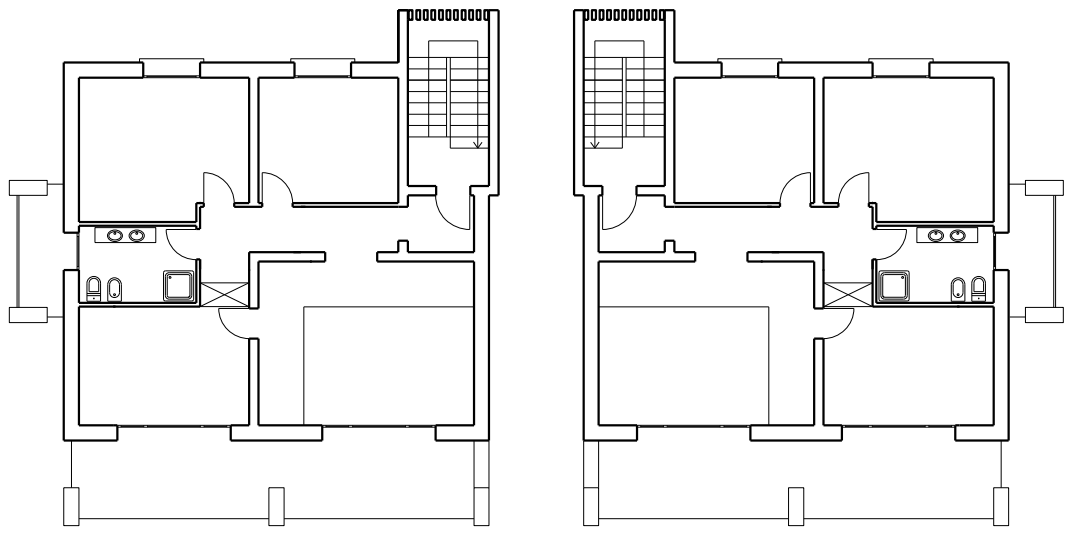

P PRIMO

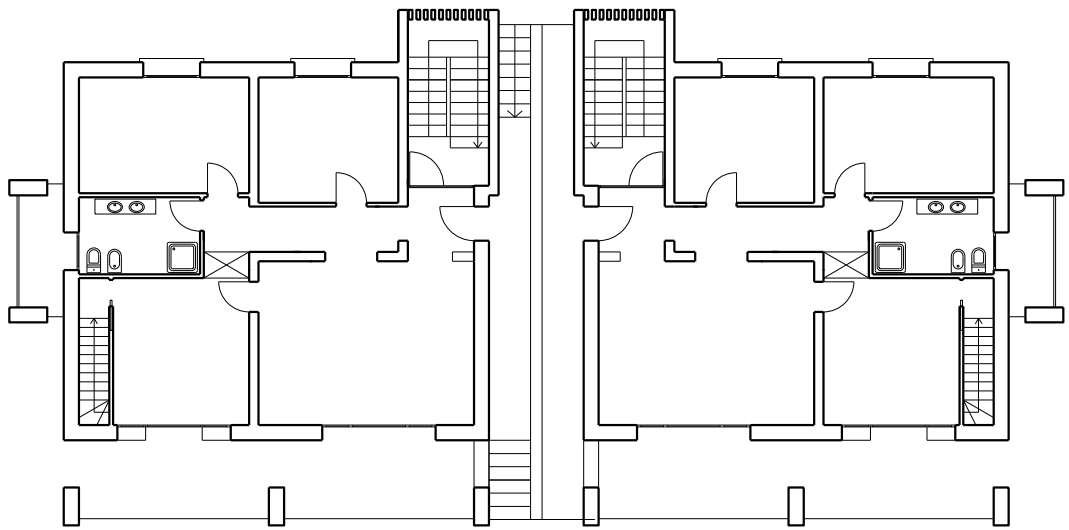

P RIALZATO

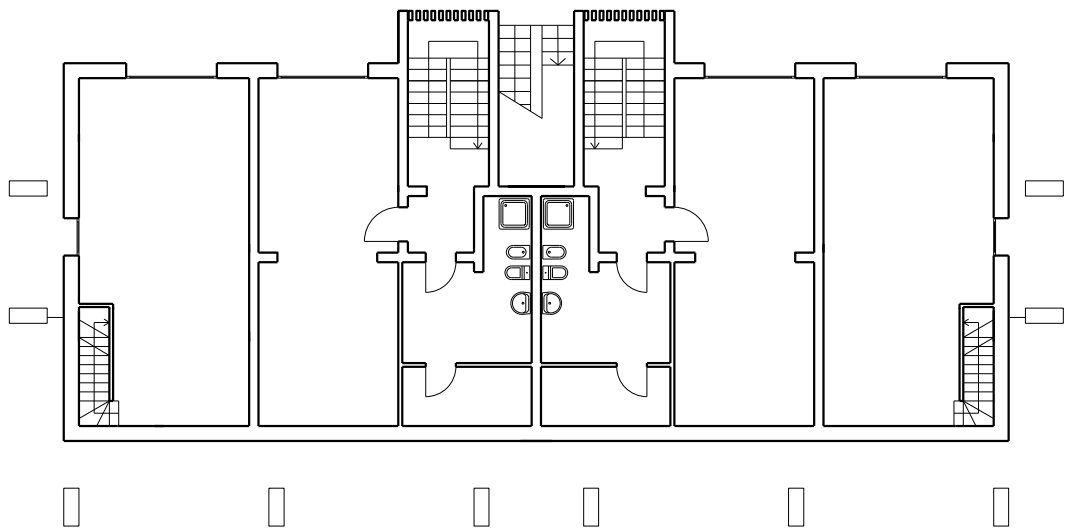

P SEMINTERRATO

TIPOLOGIA B2
SU MQ 468

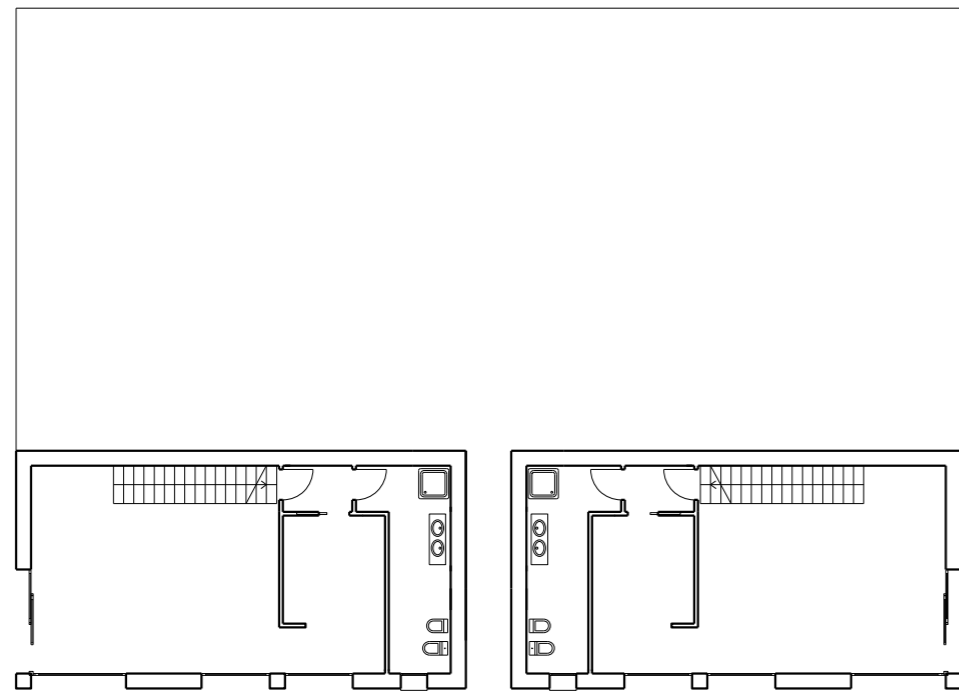

P SEMINTERRATO 1

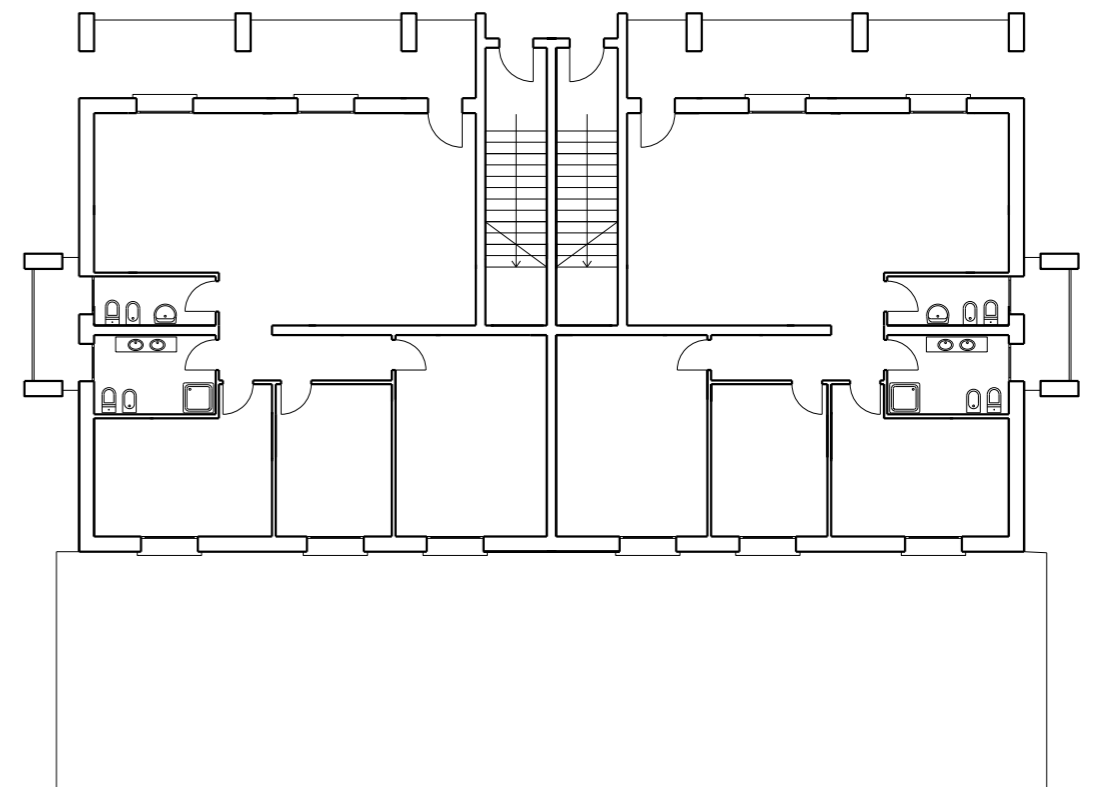

P RIALZATO

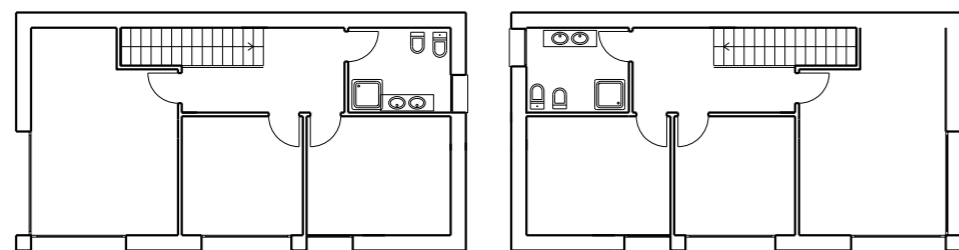
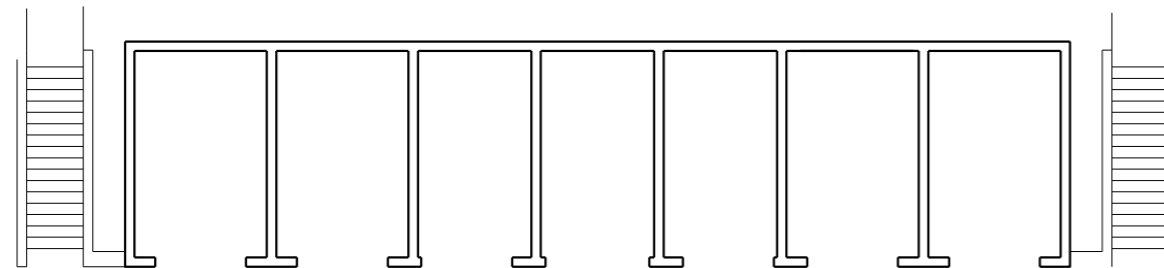

P SEMINTERRATO 2

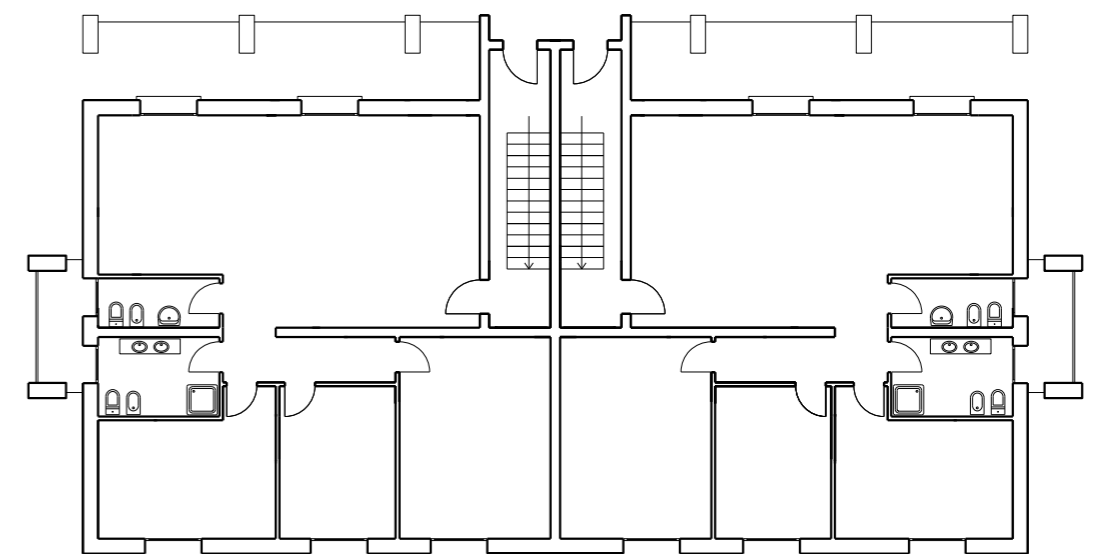

P PRIMO

**TIPOLOGIA P1
SU MQ 761**

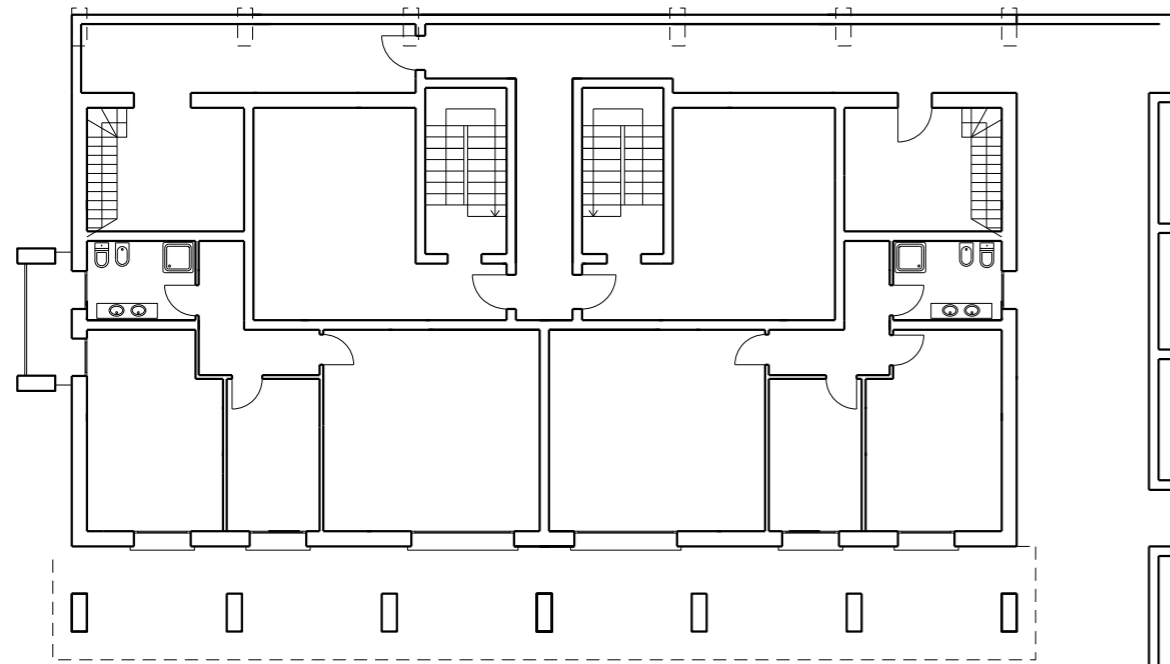

P SEMINTERRATO

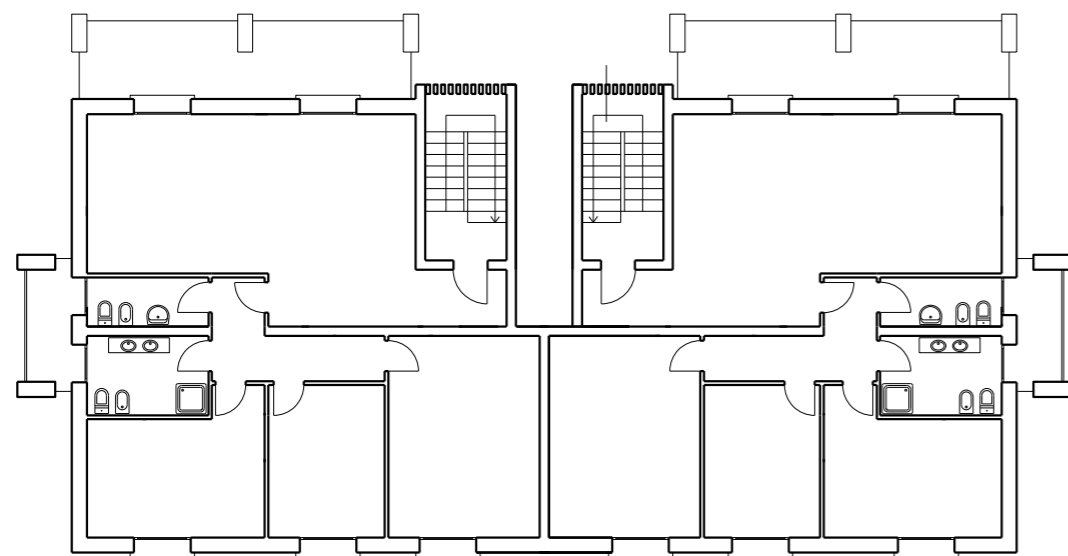
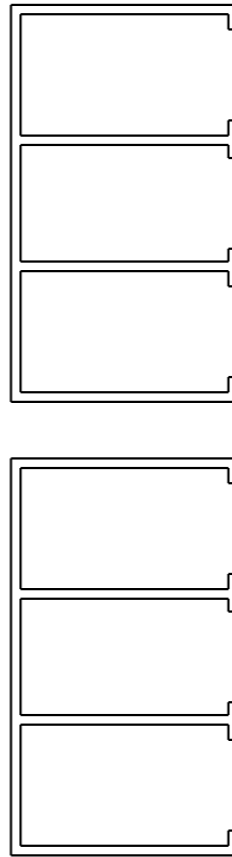

P RIALZATO

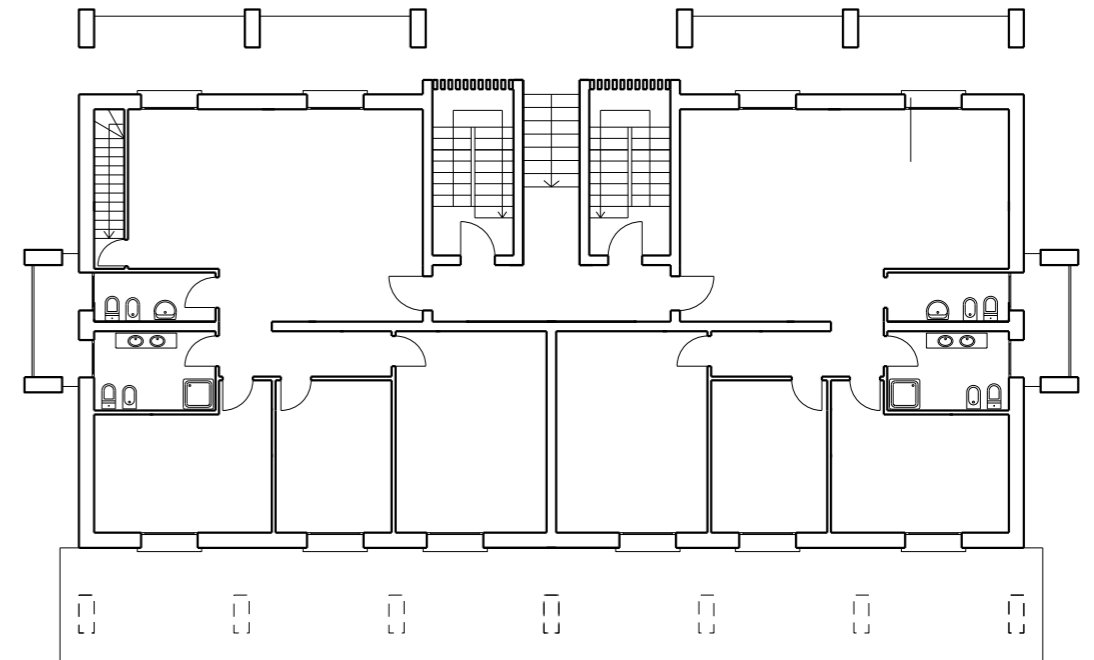

P PRIMO

TIPOLOGIA P2
SU MQ 705